



EXIT ONLY

Pedestrian Door Lock

Compliance & Certifications

Approved for Government Use

U.L. Fire Rated 90 Minute



Exit Model

Available with Push Pull Handle
and Panic Bar

The LKM10K Lock Series Exit Models are designed to control the flow of traffic into rooms with multiple entrances, while always providing single motion egress. The Exterior Trim is a simple stainless steel plate so is not an FF-L-2890B approved lock, however it was approved for Government use.

BENEFITS

Interchangeable - You can install the LKM10K Lock Series in your facility and maintain a consistent look since the appearance of the Exterior Trim has not changed.

Retrofittable - Simply remove the existing LKM7000 Lock Series attach our Retrofit Fixture modify a few existing holes then install either the Push/Pull Model or Panic Bar Model.

Field Tested - With over 25,000 LKM7000 Lock Series in use today, we are confident the improvements we have made in our next generation LKM10K Lock Series will exceed your expectations. We've conducted our own internal 1,000,000 cycle tests as well as had a unit in the field for over a year, with great success.

Easy Operation - The internal linear bearing allows for easy entry and exit even with heavy loads applied to the door.

Easy To Order - All three models include everything you need, no add-ons. You get the Pedestrian Exit Device, the combination lock, the strike, Key Override option and three internal Monitoring Switches.

Providing **Life Safety**
and **High Security**

LKM10K
High Security Life Safety Exit Device

Push Pull Handle Exit Model

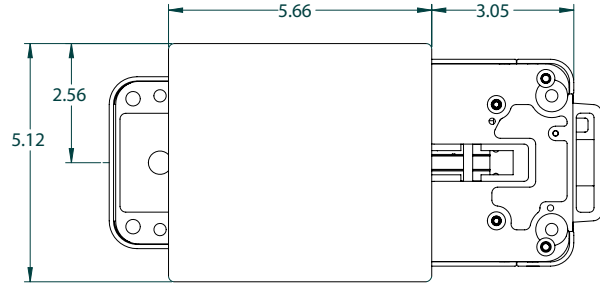
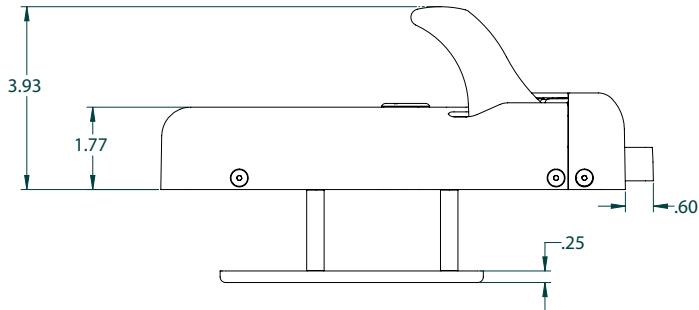
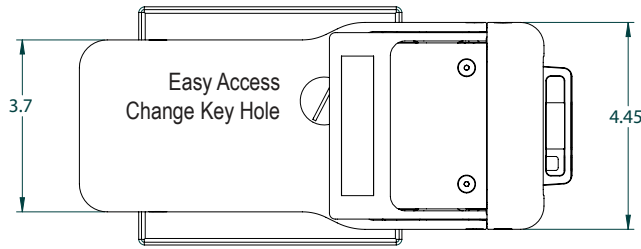

Compliance & Certifications

U.L. Fire Rated 90 Minute
U.L. 305 for Panic Devices
NFPA 80 & 101 Life Safety

Panic Bar Exit Model

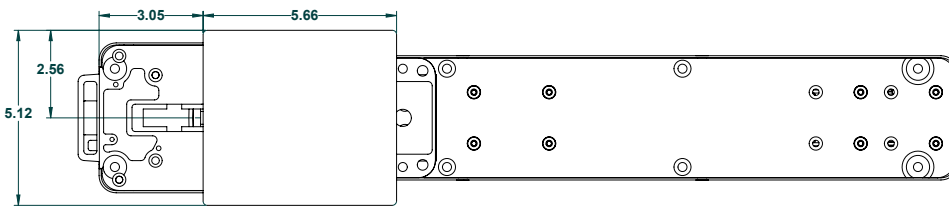
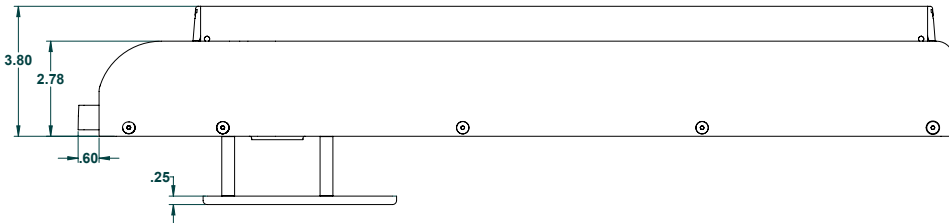
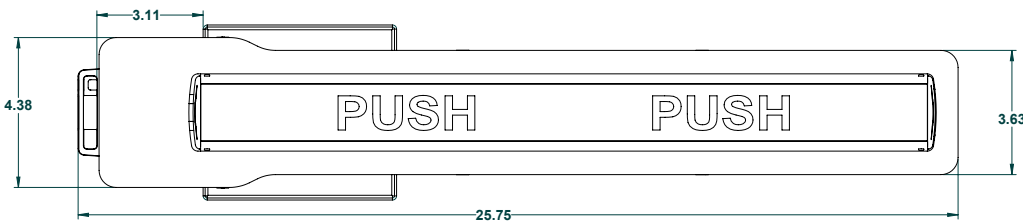

Specifications

Materials

Lock Housing - Stainless Steel
Finish - Stainless Steel & Black Powder Coat

Stainless Steel Deadbolt

Deadlocking, 7/16" throw
Encapsulated

Door Thickness

Minimum 1-1/8" - 2"; Maximum 2 5/8"

Door Types

Single or Double hung
Inswing (Push Pull Handle)
Outswing (Push Pull Handle & Panic Bar)
Hollow Metal or Wood
Metal or Wood Frames

Handing

Non-handed

Monitoring Switches

Deadbolt Switch - monitors the Pedestrian Device Bolt (Request to Exit - REX)

Strike Test

A 6,000 lb force was applied to each type of strike in the direction of the door swing.

Warranty

2 Year from purchase date

Exterior Trim Exit Model

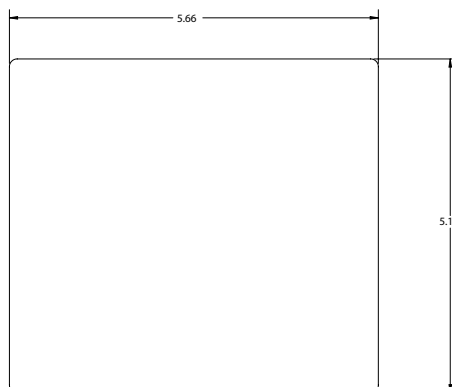
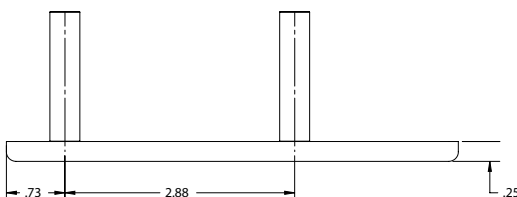

LOCKMASTERS[®]
I N C O R P O R A T E D

2101 John C. Watts Drive
Nicholasville, Kentucky 40356
800.654.0637
www.lockmasters.com
www.lkm10k.com